

A-A (Ech. 3/1)

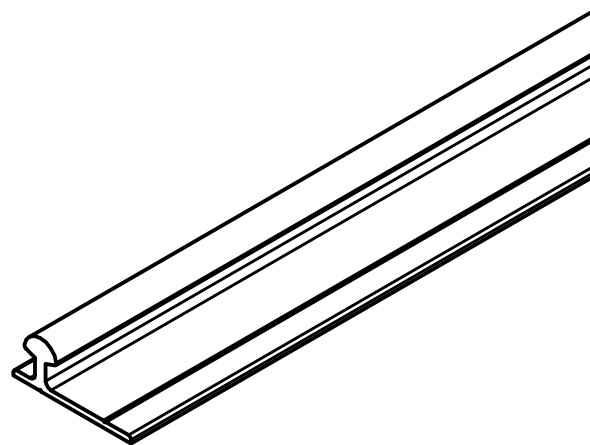

Rail à visser longueur 3 m
Matière: Aluminium

Track, screwing type Length 3 m
Matériau: Aluminium

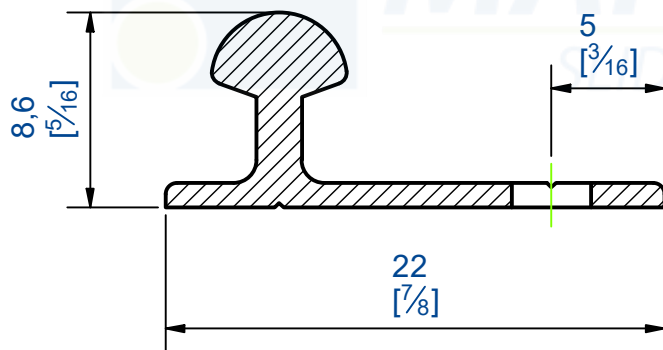

7,rue Gay Lussac
25000 BESANCON

Référence
Item Nr: **60/300**

Rail associé
Combined track: