

MANTION  
SLIDING SYSTEMS

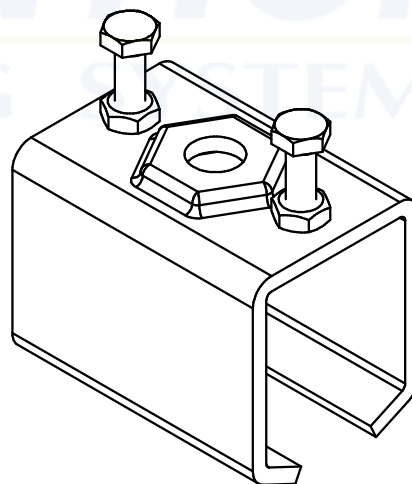

Manchon de raccordement nu  
Matière: Acier

Joiner  
Material: Steel



7,rue Gay Lussac  
25000 BESANCON

Référence  
Item Nr: **2521M**

Rail associé  
Combined track: **2525**