

Gond à souder.
Poids du portail : 80Kg

Hinges welding type.
Gate weight : 80 Kg

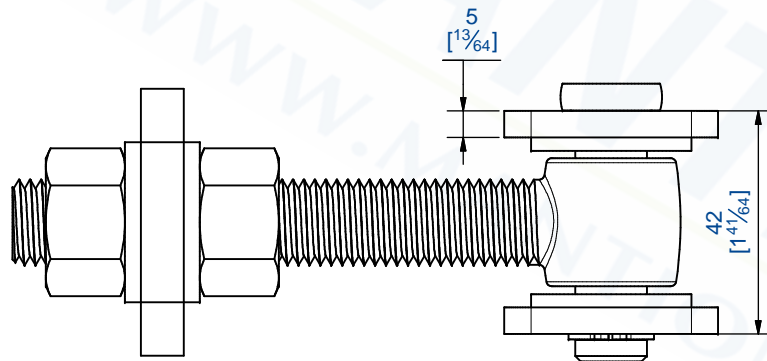
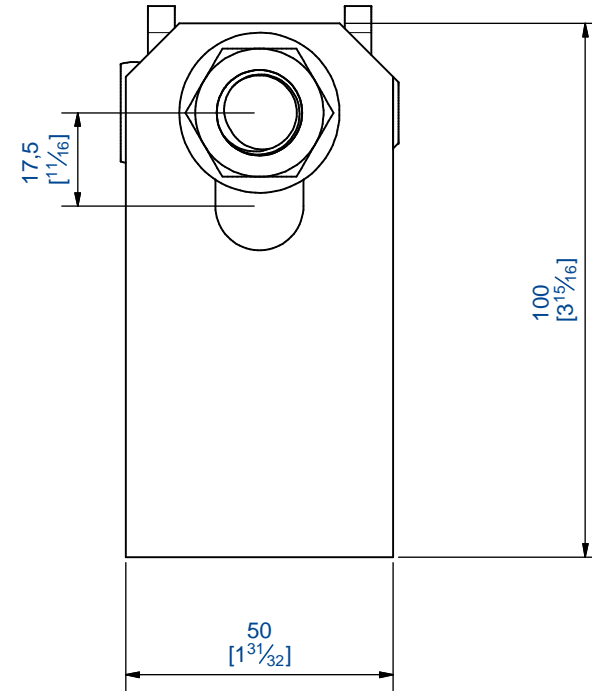
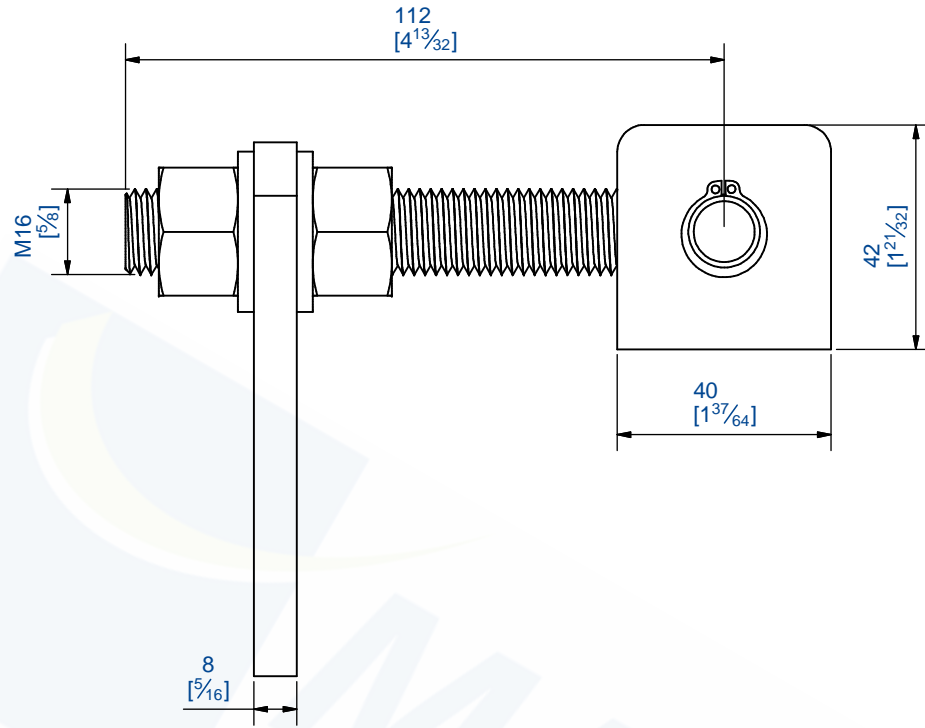

 **MANTION**
FERRURES DE PORTES COULISSANTES
MANUTENTION PAR MONORAIL
7, rue Gay Lussac
25000 BESANCON

Référence **25164SO**
Item Nr:

Rail associé
Combined track: